

Article number: 2030100M24125A1U

Description: E+G levelling foot
GN 30-100-M24-125-A1-U

Note: U Without nut, Hexagon socket at the top, Wrench flat at the bottom

Measures

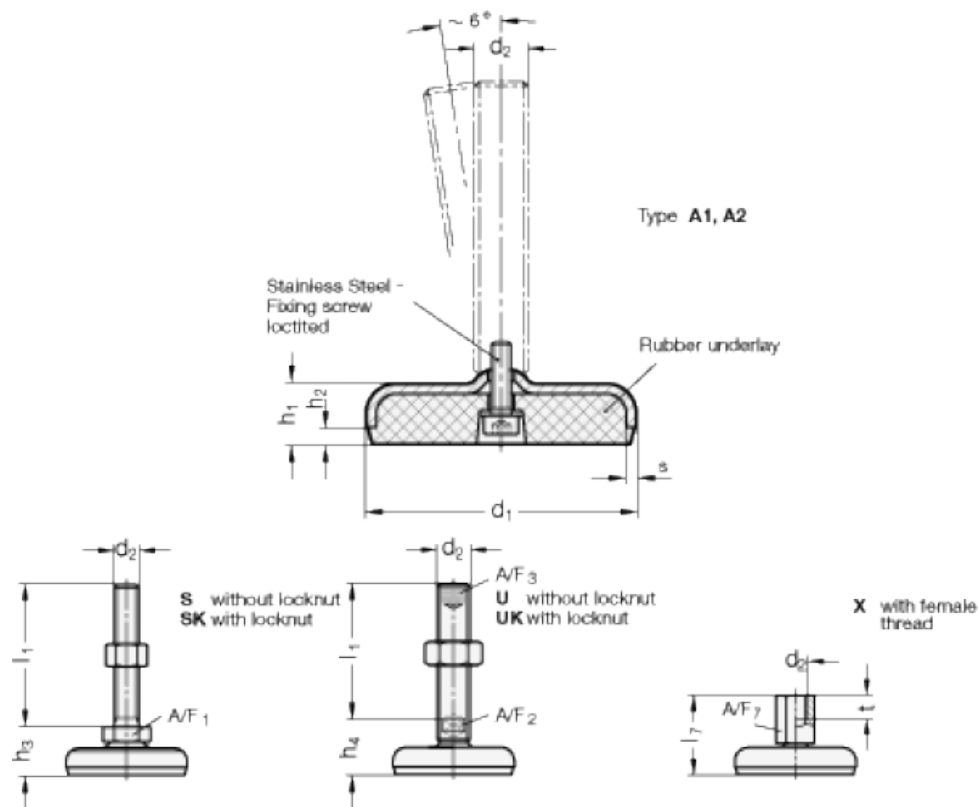

A/F2 = 19

A/F3 = 12

d_1 = 100

d_2 = M24

h_1 = 20

h_2 = 6

h_4 = 38

l_1 = 125

$s = 3$